



2022 SAILING INSTRUCTIONS

Monday-Night Series

1 RULES

The event will be governed by the rules as defined in *The Racing Rules of Sailing*.

2 CHANGES TO SAILING INSTRUCTIONS

Any change to the sailing instructions will be posted before 1745 on the day it will take effect.

3 MONDAY DATES

- 1 practice race May 16th
- 7 races May 23th through July 4th
- 7 races August 15th through September 26th

4 STARTING TIMES

The warning signal will be at 1845.

5 RADIO COMMUNICATIONS

The RC will broadcast on channel 69.

6 PERMANENT MARKS

The octagon of permanent course marks is centred at 42°20.406'N 82°50.231'W — course marks are white can buoys The start and finish line will be located at mark 4.

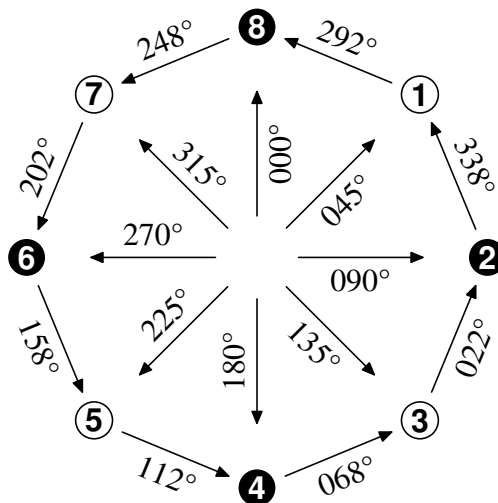

Marks are 0.75 nautical miles from the centre.
All bearings are magnetic.

Mark	Latitude	Longitude
1	42°21.003'N	82°49.618'W
2	42°20.506'N	82°49.229'W
3	42°19.951'N	82°49.427'W
4	42°19.662'N	82°50.096'W
5	42°19.809'N	82°50.844'W
6	42°20.306'N	82°51.233'W
7	42°20.861'N	82°51.035'W
8	42°21.150'N	82°50.366'W

7 COURSES

The race committee boat will display a numeral and a red or green placard identifying the course.

#2 OCTOSTAR

Placards	Marks-to-
#2 Red	Port: 1 6 3 8 5 2 7 Fin
#2 Green	Stbd: 7 2 5 8 3 6 1 Fin

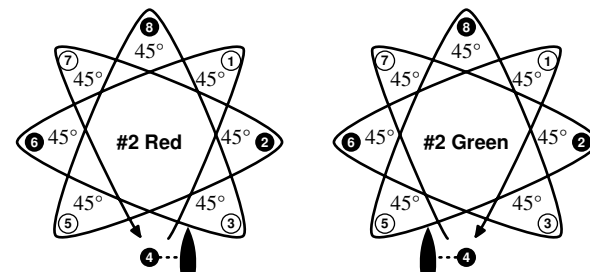

Every third mark around the circle.
Overall course length is 11.1 nautical miles.

#3 GREAT CIRCLE

Placards	Marks-to-
#3 Red	Port: 3 2 1 8 7 6 5 4 3 2 1 8 7 6 5 Fin
#3 Green	Stbd: 5 6 7 8 1 2 3 4 5 6 7 8 1 2 3 Fin

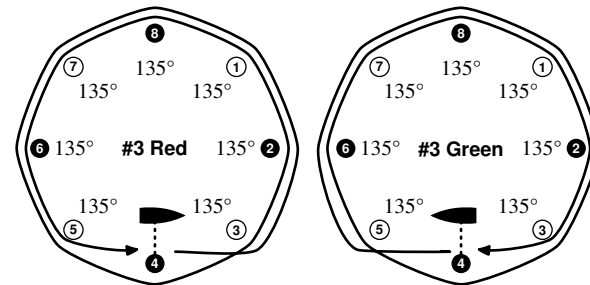

Overall course length is 9.2 nautical miles.

#4 & #5 ZIG-ZAG

Placards	Marks-to-	Marks-to-
#4 Red	Port: 2	Stbd: 6 8 Fin
#4 Green	Stbd: 6	Port: 2 8 Fin

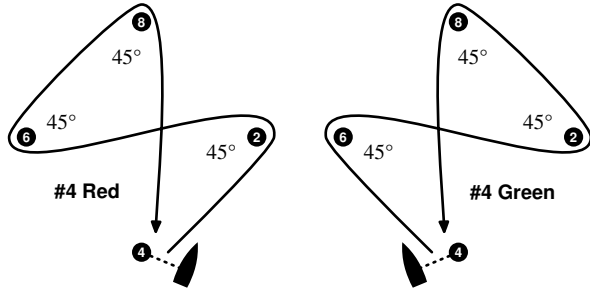

Placards	Marks-to-	Marks-to-
#5 Red	Port: 8 6	Stbd: 2 Fin
#5 Green	Stbd: 8 2	Port: 6 Fin

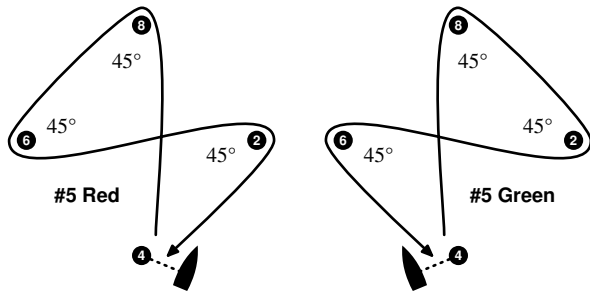

Overall course length is 5.1 nautical miles.

#6 THE PROMENADE

Placards	Marks-to-
#6 Red	Port: 3 2 1 8 7 6 5 Fin
#6 Green	Stbd: 5 6 7 8 1 2 3 Fin

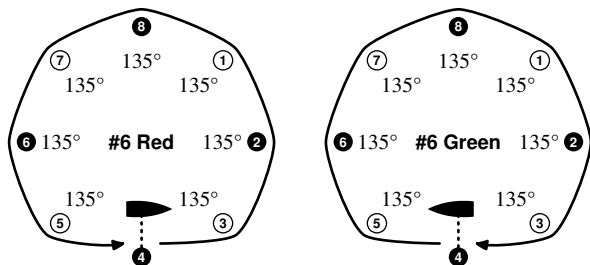

Overall course length is 4.6 nautical miles.

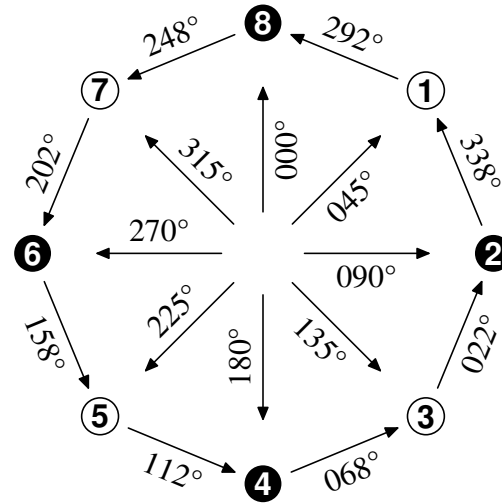
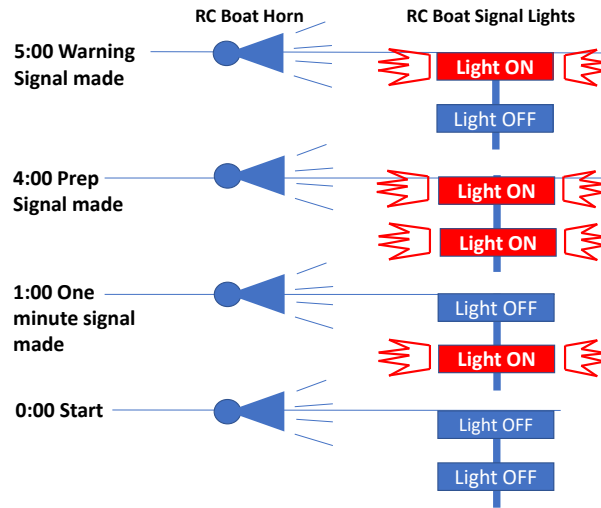

Marks are 0.75 nautical miles from the centre.
All bearings are magnetic.

8 THE START & FINISH

The starting line is between the orange flag on the race committee boat and mark 4.

The finishing line is between the blue flag on the race committee boat and mark 4.

9 STARTING RACES

Races shall be started by using the following signals. Times shall be taken from light tower signals; the absence of a sound signal shall be disregarded.

Minutes before starting signal

	Top light	Bottom light	Sound signal	Means
5	Turned on		1	Warning signal
4		Turned on	1	Prep. signal
1	Turned off		1 long	One minute
0		Turned off	1	Starting signal

This replaces rule RRS 26 and RRS Race Signals Preparatory Signals.

10 TIME LIMITS

The race time limit is two hours.

Boats failing to finish within 1 hour after the first boat starts, sails the course and finishes will be scored Did Not Finish without a hearing. This changes rules RRS 35 and RRS A5.1.

11 HEARING REQUESTS

The protest time limit is 1 hour after the race committee boat docks.